

EFFECT OF TRANSIENT EVENT FREQUENCY CONTENT AND SCALE ON THE HUMAN DETECTION OF ROAD SURFACE TYPE

J. A. Giacomini

Brunel University
School of Engineering and Design
Uxbridge, West London, UB8 3PH, UK
Joseph.Giacomini@brunel.ac.uk

T. P. Berber-Solano

The University of Sheffield
Department of Mechanical Engineering
Mappin Street, Sheffield S1 3JD
mep03tpb@sheffield.ac.uk

ABSTRACT

This paper describes two laboratory-based experiments which evaluate the effect of transient event frequency content and scale on the human detection of road surface type by means of steering wheel vibration. This study used steering wheel tangential direction acceleration time histories which had been measured in a mid-sized European automobile that was driven over two different types of road surface. The steering acceleration stimuli were manipulated by means of the mildly non-stationary mission synthesis (MNMS) algorithm in order to produce test stimuli which were selectively modified in terms of the number, and size, of transient vibration events they contained. Fifteen test participants were exposed to both unmanipulated and manipulated steering wheel rotational stimuli by means of a steering wheel vibration simulator. For each road surface type a total of 45 vibration test stimuli were presented to each participant. Each participant was asked to state, by means of a simple "yes" or "no" answer, whether each individual stimuli was from a road surface which was being presented in front of the simulator as a picture on a large board. Using Signal Detection Theory as the analytical framework the results were summarized by means of the detectability index d' and by means of receiver operating curve (ROC) points. Improvements of up to 20 percentage points in the rate of correct detection were achieved by means of selective manipulation of the steering vibration stimuli. The results suggested that no single setting of the MNMS algorithm proved optimal for both two road surface types that were investigated.

1. INTRODUCTION

The steering wheel is commonly considered the most important source of haptic feedback information for the automobile driver. This is due to the great sensitivity of the skin tactile receptors of the hand [1][2], as well as the lack of intermediate structures such as shoes and clothing which can act to attenuate the transmission of vibrational stimuli to the driver. In this context, the word 'stimuli' is taken to mean something external that elicits or influences a psychological activity or response on the part of the driver [3]. In order to produce road vehicles which have a high level of quality and comfort, automobile manufacturers dedicate significant attention to *noise and vibration suppression* [4]. This results in a suppression of stimuli. For many years, psychologists, cognitive scientists, cognitive psychologists, and others have established the relation between stimuli and information [5][6][7][8]. Given the above, the question of what information a road automobile subsystem should transmit to the driver is not a simple one. According to [9] vibrational stimuli help in the interpretation of many things including the type of road surface, the presence of water or snow, tyre slip and the dynamic state of subsystems such as the engine, the steering and the brakes. Giacomini and Woo [9] have stated that the haptic steering stimuli are perceived, compared to models from long term memory and interpreted, with the consequent interpretation then influencing decision making. With the advent of electronically assisted steering and 'by-wire' technologies the question of which stimuli should reach the driver assumes great importance [10][11][12]. From a comfort point of view, less steering vibration should be judged as better. This is not appropriate in the case of information, however, since scenarios can be imagined in which

an increase in vibration level can help to clarify the nature of the road surface or the automobile dynamic state [9].

Marcotte [13] states that “driving an automobile engages several cognitive abilities and although many driving behaviors are overlearned, drivers frequently need to respond to circumstances requiring intact attention, spatial processing, processing speed, and executive functioning (self-monitoring or judgment)”. Studies have shown that the global performance of a coupled person-machine system can be improved when certain low level perceptual and cognitive functions are assigned to the machine [14]. Human information-processing characteristics are therefore central to the design of many modern systems. Examples of this trend include graphical displays that tailor to human perceptual characteristics [15][16][17], systems whose design involves the use of human performance models that enable explicit consideration of human memory and attentional constraints [18][19], and error tolerant systems developed to minimise human error [20][21][22].

The concept of Perception Enhancement Systems (PES) emerges from the observation that not all machine emissions are informative, and that only certain cognitively-relevant features from the environment have meaning for humans. One means of improving the flow of information to the driver, and thus of making the driving task easier, is to incorporate a Perception Enhancement System into the design of the automobile steering as shown in Figure 1. Giacomini [23] has proposed the definition that an automotive steering Perception Enhancement System is any device which optimises the feedback to the driver of information about automobile interaction with the environment. Such systems treat the data from an information theoretic point of view, and optimise the person-machine interface so as to make the automobile feel more like an extension of the driver’s body. Such a system might be composed of electronic systems which have the function of identifying the significant vibration stimuli (originating from the tyres and suspensions) which are required by the driver, and of transforming the stimuli in order to optimise detection and awareness [9].

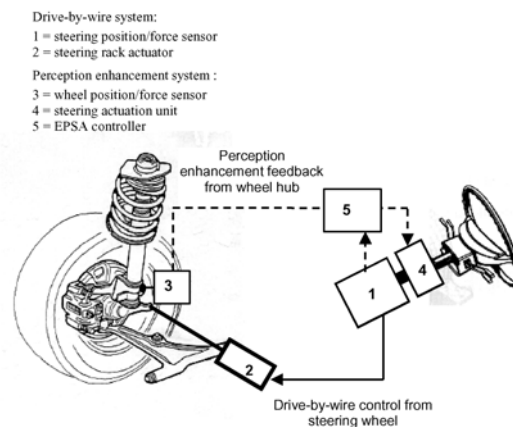

Figure 1. A Perception Enhancement System (PES) for use with “by-wire” automotive steering.

In a modern automobile, the electrical and electro-mechanical power assistance systems used for the primary controls (steering, acceleration and braking) make these controls obvious choices for the application of low level perceptual and cognitive functions such as a steering perception enhancement system. An example of research in this direction is the study by Giacomini and Woo [9], which investigated driver detection of road surface type. By measuring the sensitivity of the human detection task to changes in the primary characteristics (scale and bandwidth) of the vibration stimuli, the authors defined the basic dynamic specifications that an automotive steering system should have in order to be capable of applying low level perceptual assistance to the driver. The authors concluded that a single, fixed, feedback gain was not optimal. Rather, the data supported the view that the optimal steering feedback gain should be determined after automated classification

of the road surface type. Further, the authors defined a minimum bandwidth requirement, of approximately 0 to 80 Hz, required by drivers for the detection task.

The study presented in this paper treats instead the problem of features [23], which can be defined to be the effect that individual vibrational transient events have on human cognitive response. A natural question which arises in the case of the steering system is whether short, sharp, transients of the kind that occur when driving over cracks or stones effect the detection of the surface type. The study presented here investigated the effect of the number of transient events, and the effect of the scale of the transient events, on the human detection of road surface type. The study was performed by means of laboratory-based experiments involving human participants, and involved digital manipulation of steering wheel tangential acceleration signals which were measured during road testing of a mid-sized European automobile.

2. THEORY OF SIGNAL DETECTION

Theory of Signal Detection (TSD) is an approach which facilitates the measurements and quantification of how people actually behave in detection situations [24]. TSD is described in detail in [25]. The starting point for signal detection theory is the assumption that nearly all reasoning and decision making takes place in the presence of some uncertainty. The general approach finds direct application in terms of sensory experiments, and is often used to analyze different kinds of decision making [26]. There are many applications for the Theory of Signal Detection including Models of Visual Detection [27], Models of recognition memory [28] and as a source of monitoring [29].

Theory of signal detection is applicable in any situation in which a signal is to be detected while in the presence of background noise [25]. In the detection situation, the observer must therefore first make an *observation* (x) and then make a decision about the *observation*. On each trial, the observer must decide whether x is due to a signal added to the noise background or to the noise alone. According to Gescheider [30], as a weak signal is applied the decision becomes difficult and errors are frequent. Figure 2 represents graphically two distributions which describe the random variation of the noise, and of the signal plus the noise. Since the signal is added to the noise, the average sensory observation magnitude will always be greater for the signal-plus-noise distribution than for the noise distribution, but when the distributions are essentially the same, they greatly overlap, making the decision difficult.

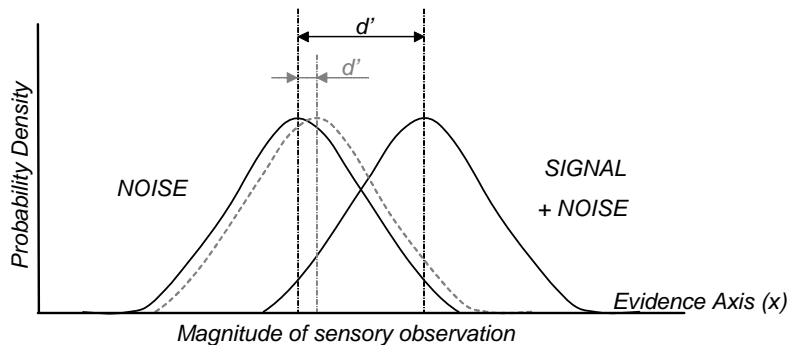

Figure 2. Theoretical frequency distributions of noise and signal noise for two different values of signal strength (Adapted from [31]).

The combination of two stimulus and two response categories produces the 2×2 matrix shown in Figure 3. It involves four classes of joint events which are labelled as hits, misses, false alarms, and correct rejections.

		Responses	
		Yes	No
Stimulus	Signal +Noise	<i>Hit</i> (Correct detection)	<i>Miss</i> (Incorrect rejection)
	Noise	<i>False alarm</i> (Incorrect detection)	<i>Correct rejection</i> (Correct denial)

Figure 3. *The four response outcomes of signal detection.*

3. EXPERIMENTAL TESTS OF HUMAN COGNITIVE RESPONSE TO STEERING WHEEL VIBRATION

3.1. Test Stimuli

The experiments involved tangential direction acceleration time histories which were originally measured in an Audi A4 when driving over two road surfaces. The automobile used to provide the acceleration stimuli for the experiments can be considered an average European saloon with average mechanical characteristics. The road surfaces that were measured were a tarmac surface and a cobblestone surface. Figure 4 presents the two road surfaces, as viewed from directly above, and as seen from a distance as when driving. For each road surface a 2 minutes data recording was available from experimental testing (see reference [32]). From each 2 minutes recording a 10 seconds segment was extracted for use in the current experiments which was statistically representative of the complete 2 minutes recording. For purposes of illustration, 3 second segment of the acceleration time histories of the two base stimuli are presented in Figure 5, while the related global statistical properties are presented in Table 1.

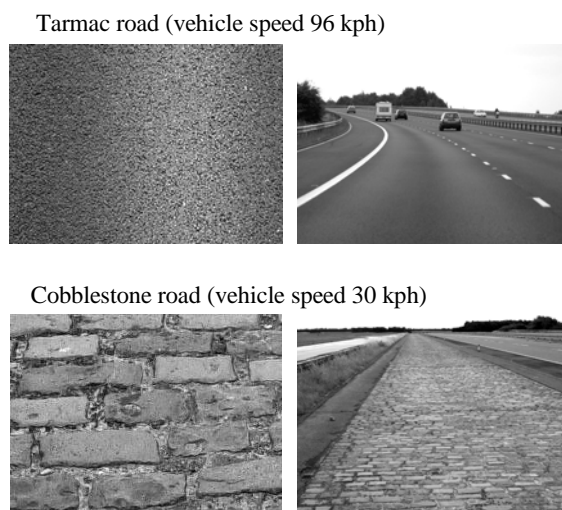

Figure 4. *Road surfaces whose stimuli were chosen for use in the laboratory tests.*

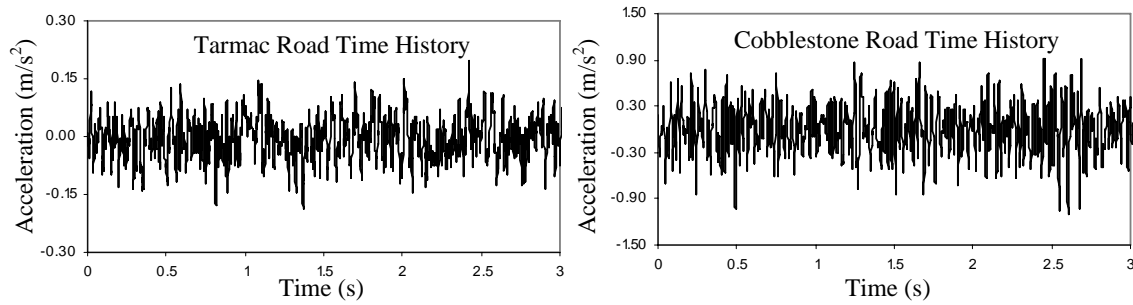

Figure 5. Steering wheel acceleration time history segments used the base stimuli.

Table 1. Global statistics and characteristics of the two base stimuli used for producing the laboratory test stimuli.

Global Statistics & characteristic	Tarmac Surface	Cobblestone Surface
r.m.s. (m/s^2)	0.05	0.27
Kurtosis (dimensionless)	3.00	3.25
Speed (kph)	96.00	30.00

The extraction of transient events from the base stimuli, and the reinsertion of modified (either in number or size) transient events into the test stimuli, was achieved by means of the mildly non-stationary mission synthesis (MNMS) algorithm [33]. MNMS acts as a compression tool to produce a shortened stimuli sequence starting from a long non-stationary time history. MNMS uses the discrete Fourier transform (DFT), the orthogonal wavelet transform (OWT) and transient event reinsertion procedures. By means of the MNMS algorithm it was possible to selectively manipulate the transient events which were present in the original steering vibration stimuli.

The mildly non-stationary mission synthesis algorithm splits an original signal into wavelet levels [34][35]. Wavelet levels consist of time histories which are obtained from the wavelet decomposition, and contain the signal energy which is specific to a specific frequency band. MNMS uses the orthogonal wavelet transform to divide the overall energy into individual signals, in a manner analogous to a parallel bank of band-pass filters. A feature which is specific to MNMS is a wavelet grouping stage which permits the user to group individual wavelet levels into larger regions of significant energy, as illustrated in the PSD plots of Figure 6, where each wavelet group (WG1, WG2, etc.) consists of two or more automatically generated wavelet levels. For the two acceleration stimuli used in the current study, the signal was automatically divided into 12 wavelet levels, which were then grouped based on user inputs into 4 wavelet groups for the cobblestone stimuli and 5 wavelet groups for the tarmac stimuli. As shown in Figure 6, the wavelet groups were ordered from the lowest frequency to the highest frequency for simplicity.

In MNMS, transient events are defined as oscillations which have monotonic decay properties on either side of a central maximum. Two inversion points, one on either side of the peak value, define the temporal extent of the transient event, as shown in Fig. 7. Transient event identification is achieved in each wavelet group time history by means of a user selected trigger level that is specific to the wavelet group [33]. In the current study the wavelet group trigger levels were chosen to be in the range from 2.6 to 3.4 standard deviations. Table 2 presents the trigger level values chosen for each individual wavelet group, as well as the number of transient events that were extracted from the original stimuli (NBE) and the number of transient events that were reinserted into the test stimuli (NBR). Test signals were produced from each of the two experimentally

acquired base signals using four time compression ratios of 1.0, 2.0, 3.0 and 4.0 and five transient event scale factors of 0.8, 1.0, 2.0, 3.0 and 4.0.

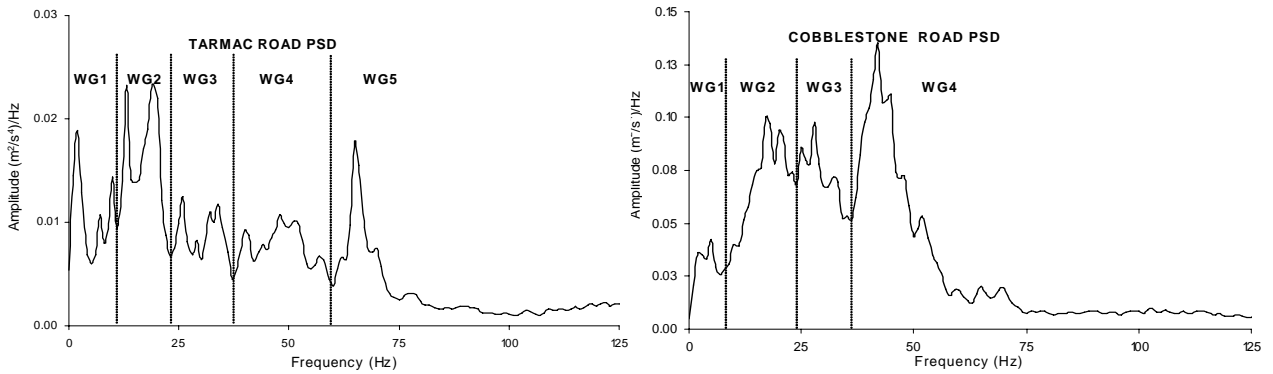

Figure 6. Power spectral densities of the steering acceleration time histories, showing the wavelet group boundaries chosen for use in the current study.

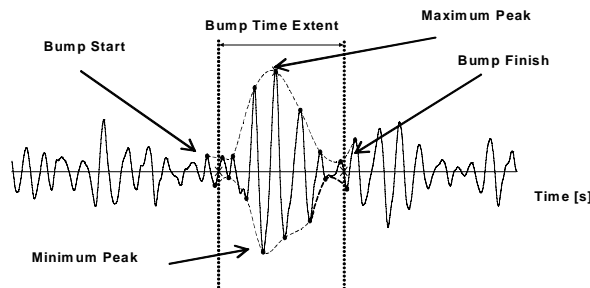

Figure 7. Example of a typical transient event identified by the MNMS algorithm.

Table 2. Wavelet group transient event trigger levels used in the current study.

SIGNALS	CR	WG1	WG2	WG3	WG4	WG5	NBE	NBR
TARMAC	1.0							53
	2.0	2.60	3.10	3.30	3.40	3.50	53	53
	3.0							49
	4.0							44
COBBLE-STONE	1.0							
COBBLE-STONE	2.0	2.80	3.30	3.10	3.00	-	53	53
	3.0							53
	4.0							52

WG= Wavelet Group
 NBE= number of transient events extracted.
 NBR= number of transient events reinserted.

3.2. Test Facility

The steering wheel rotational test rig that was used is presented in Figure 8. The rotational system consisted of a 325mm diameter aluminium wheel attached to a steel shaft which was in turn mounted to two bearings. The shaft was connected to the electrodynamic shaker head by means of a copper stinger-rod. Table 3 presents the main geometric dimensions of the test rig, which were chosen based on data from a small European automobile. The seat was fully adjustable in terms of horizontal position and back-rest inclination as in the original vehicle. Rotational vibration was applied by means of a G&W V20 electrodynamic shaker driven by PA100 amplifier [36]. The steering wheel tangential acceleration was measured by means of an Entran EGAS-FS-25 accelerometer attached to the top left side of the wheel. The accelerometer signal was amplified by means of an Entran MSC6 signal conditioning unit [37]. Control and data acquisition are performed by means of the LMS TMON software system coupled to a DIFA SCADASIII unit [38].

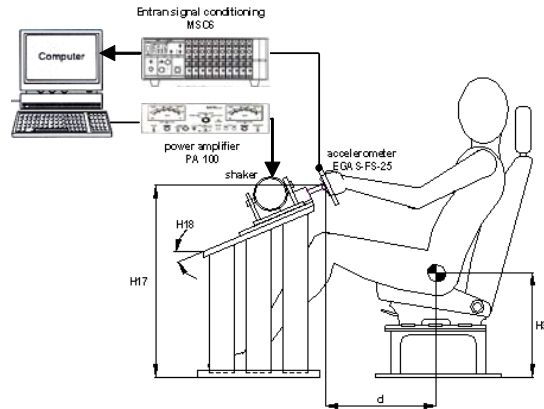

Figure 8. *Steering wheel rotational vibration test facility.*

Table 3. *Geometric dimensions of the steering wheel rotational vibration test rig*

<i>Geometric Parameter</i>	<i>Value</i>
Steering column angle (H18)	23°
Steering wheel hub centre height above floor (H17)	710 mm
Steering wheel diameter (W9)	325 mm
Steering wheel tube diameter	12.5 mm
Horizontal distance from H point to steering wheel hub centre (d= L11-L51)	390–550 mm
Seat H point height from floor (H30)	275 mm

3.3. Test Subjects

15 university staff and students participated in the laboratory experiments (9 males and 6 females). The mean age for the group was 28.2 years, while the mean height was 1.72 m and the mean mass was 72.6 kg. No participant declared any condition which might effect the perception of hand-arm vibration, and none declared having ingested coffee prior to testing.

3.4. Test Protocol

Upon arriving in the laboratory, each subject was asked to sit in the test rig and to adjust the seat so as to achieve a realistic driving posture. He or she was then asked to fix his or her eyes on a board directly in front of the bench, which displayed a picture of a road surface. Prior to commencing formal testing, the subject was provided an example of each of the two stimuli types which would be used later, in order to become acquainted with the detection task.

The detection task was to state, by means of “yes” or “no”, whether each vibration stimuli that was actuated during the course of the experiment was from the road surface that was illustrated by the picture on the board directly in front of the test bench. When the actuated vibration stimuli had been produced using the base stimuli from the displayed road surface, the response was taken to be a correct detection. False alarms, on the other hand, were taken to be those situations when the participant responded “yes” to a stimulus which was not derived from the displayed road surface. No feedback was provided by the experimenter to the test participant regarding whether the identifications were correct or incorrect.

Two laboratory experiments were performed. A single road surface was displayed in front of the participant during each experiment. The stimuli actuated at the wheel during each experiment consisted of an ensemble of 10 second test stimuli, each of which was either an original base stimuli or a modified derivative which has been defined starting from the two experimentally measured acceleration time histories. Three different series of 15 tangential acceleration stimuli were applied to evaluate each road surface type. In each series, each stimulus was separated from each other stimulus by a 5 second gap in which the participant was asked to state his or her judgment of road surface type. The order of stimuli presentation was fully randomised for each participant in each experiment.

4. RESULTS

Figure 9 presents the results obtained from the experiment to determine the effect of the number of transient events on the human ability to detect road surface type. The results are presented in terms of percent correct detection, from 0 to 100 percent. Percent correct detection is presented along the ordinate, while the ratio of signal compression (the increases in the number of transient events) is presented along the abscissa. The original base stimuli are labelled as O, and the four compressed test stimuli are labelled as +1, +2, +3 and +4 to indicate compression ratios from 1 to 4. Figure 9 also presents the detectability index d' values [31], from -1 to 3, determined from the hit and false alarm rates obtained from the tarmac and cobblestone sessions. Both the detection rate and the detectability results suggest similar human response to both stimuli types. For both road surfaces the result suggests that optimal detection does not occur at the natural number of transient vibration events measured in the road vehicle. Significant increases in correct detection occurred for all compression ratios greater than 2 for the cobblestone stimuli, and for the compression ratios of 1 and 2 for the tarmac stimuli.

The performance of each participant, specified as a hit rate and a false alarm rate, can also be represented as a single point on a receiver operating curve (ROC). Figure 10 presents the ROC points for the tarmac surface. The data confirms the improvement in detection where occurred for the compression ratios of 1 and 2.

Figure 11 presents the results obtained from the experiment to determine the effect of transient event scaling on the human ability to detect road surface type. The stimuli used in this experiment had a compression ratio of 2.0, which was chosen because it was the mean compression ratio considered in the current study. The results are again presented in terms of percent correct detection, from 0 to 100 percent, and in terms of detectability index values, from 0 to 3. The scale factors applied to the individual transient events (0.8, 1.0, 2.0, 3.0 and 4.0) by means of the MNMS algorithm are presented along the abscissa.

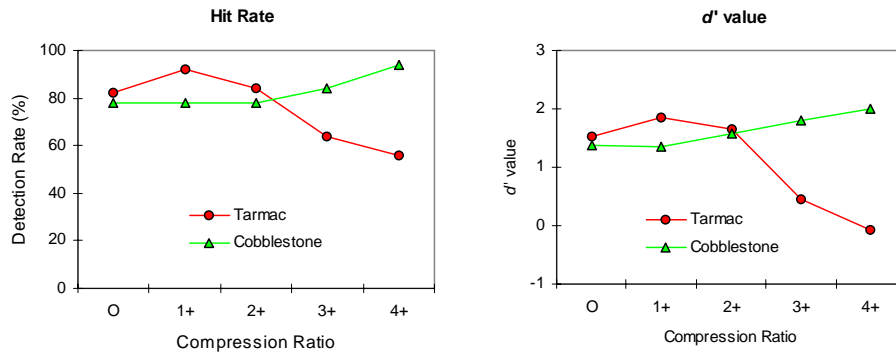

Figure 9. Results of the laboratory experiment to measure the effect of the number of transient events on the human detection of road surface type.

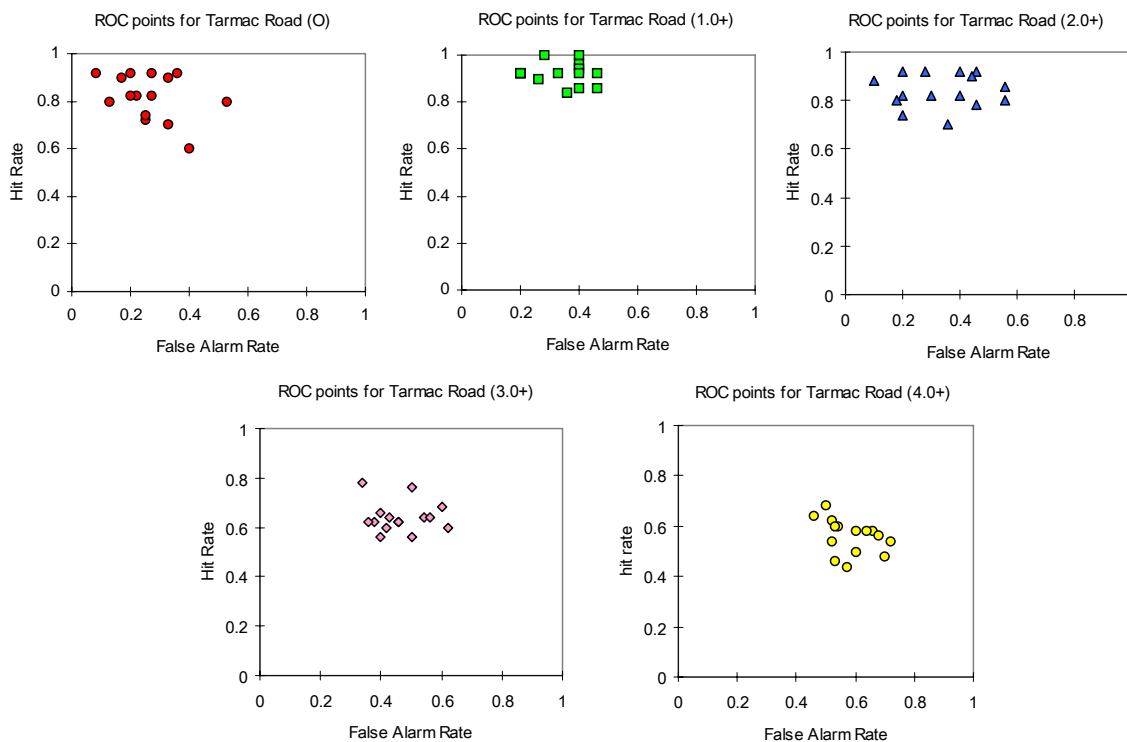

Figure 10. ROC points of tarmac surface for the laboratory experiment to measure the effect of the number of transient events.

For the stimuli involving transient events which were maintained at their natural scale (x1.0), the percentages of correct detection were 78% for the cobblestone stimuli, and 92% for the tarmac stimuli. In the case of the cobblestone stimuli the optimum detection was achieved at the largest scale that was tested (x4.0), while for the tarmac stimuli optimal detection occurred for the smallest scale value tested (x0.8). For both road surface types, optimal detection occurred for stimuli having transient events which were different in size from those occurring naturally in the original stimuli.

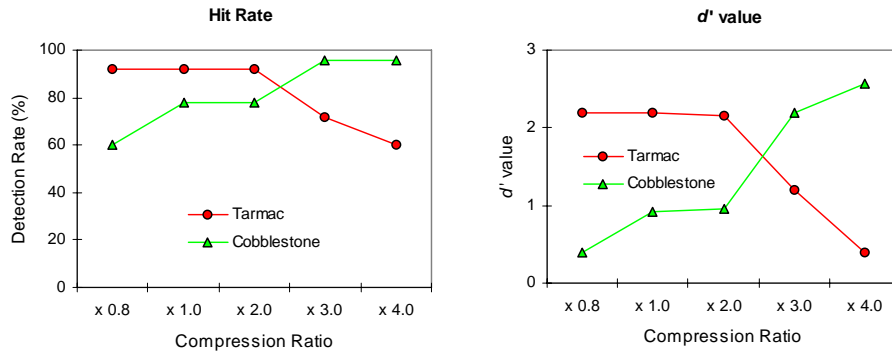

Figure 11. Results of the laboratory experiment to measure the effect of transient event scaling on the human detection of road surface type.

Figure 12 presents the receiver operation curve points for the group of subjects who performed the bump scaling experiment for the cobblestone road surface. It can be seen that the data also confirms the improvement in detection where occurred at the largest scale tested.

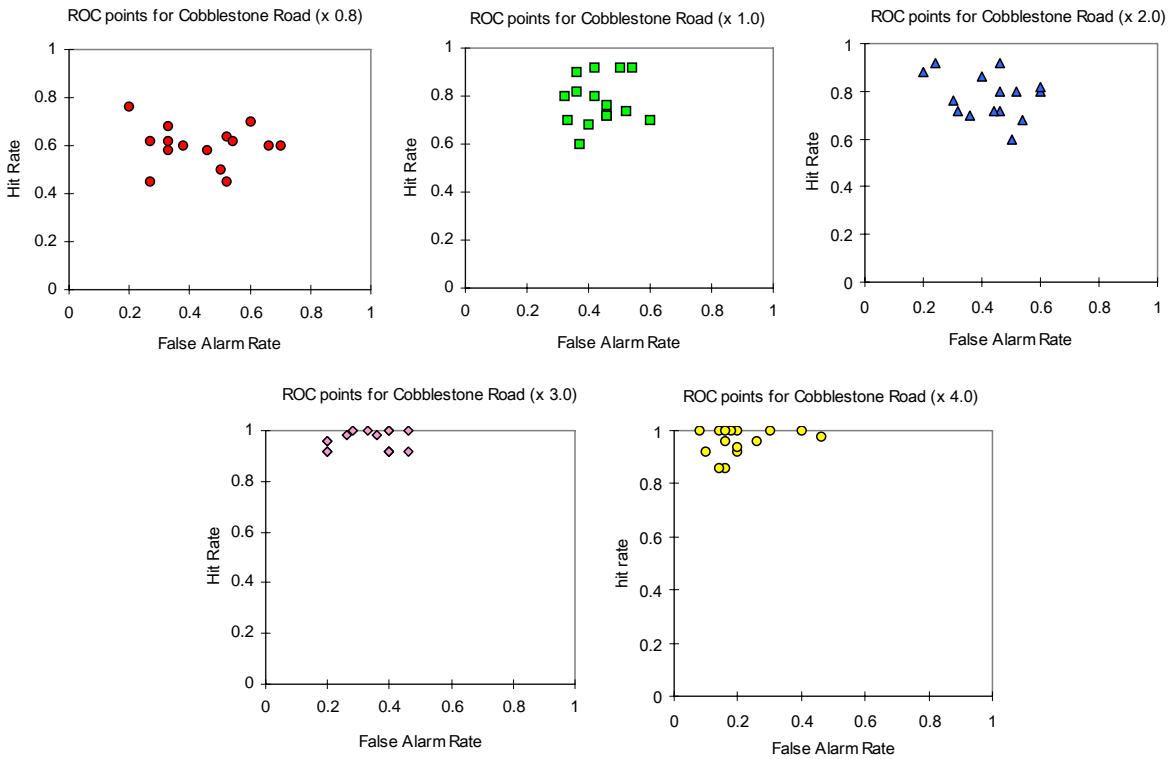

Figure 12. ROC points of cobblestone surface for the laboratory experiment to measure the effect of the transient events scaling.

5. DISCUSSION

Comparison of the current results to those previously obtained by Giacomini and Woo [9] suggests similarities. The curves of percent correct detection and those from the detectability index d' which are presented here, both

those as a function of transient event frequency and those as a function of transient event scale, show similar qualitative behaviour to the curves defined in [9] as a function of overall signal scale. For example, the monotonic improvement in detection rate as a function of increasing compression ratio found for the cobblestone surface in this study mirrors the monotonic increase obtained in [9] as a function of overall signal scale, but with smaller changes in detection across the various test conditions.

The results of both the previous study [9] and the current study suggest that the manipulation of steering wheel vibrational feedback can improve driver detection of the road surface. In the current study, the rate of correct detection was improved by as much as 20 percentage points by the adoption of stimuli manipulation.

The results of both the previous study [9] and the current study also suggest, however, that a fixed increase in the frequency of transients events, or a fixed increase in transient event scale, or a fixed change of overall signal scale, will not lead to improved road type detection in the case of all road surface types. Individual road surface types appear to require individual signal manipulation settings. The conclusion suggests that an important function of an automobile perception enhancement system would be that of pattern recognition. Automated real-time classification of stimuli type would permit a perception enhancement system controller to determine the needed optimal feedback gains.

6. ACKNOWLEDGMENTS

The authors thank the CONACyT for their economic support of the research and thank colleagues at MIRA for providing the steering and suspension data.

7. REFERENCES

- [1] Lee, S. I. Human sensitivity responses to vibrotactile stimulation on the hand: measurement of absolute thresholds. *J. Ergonomics Soc. South Korea*, 1998, 17(2), 1–10.
- [2] Morioka, M. Effect of contact location on vibration perception thresholds in the glabrous skin of the human hand. In Proceedings of 34th UK Group Meeting on *Human Responses to Vibration*, 22–24 September 1999 (Ford Motor Company, Dunton, Essex).
- [3] Oxford English Dictionary, 2001.
- [4] Harrison, M., *Vehicle Refinement, Controlling Noise and Vibration in Road Vehicles*. Elsevier Butterworth-Heinemann, 2004.
- [5] Newell, A., *Unified Theories of Cognition*, Harvard University Press, 1990.
- [6] Simon, H. A., Information processing models of cognition. *Annual Review of Psychology*, 30, 363–396, 1979.
- [7] Gibson, E. J., *Principles of perceptual learning and development*. New York: Appleton-Century-Crofts, 1969.
- [8] Loomis, J. M. and Lederman, S. J. Tactual perception. *Handbook of Human Perception and Performance*, Wiley, NY, 1986.
- [9] Giacomini, J. and Woo, Y.J., Beyond comfort: information content and perception. *Engineering Integrity*, Vol. 16, July, 2004, pp 8-16.
- [10] Bretz, E. A., By-Wire Cars Turn the Corner. *IEEE Spectrum*, April 2001. http://ees.mit.edu/public/In_the_News/By-Wire+Cars.pdf.
- [11] Jurgen, R. K., *Electronic Steering and Suspensions Systems*, S.A.E. International, Warrendale Pennsylvania, 1999.
- [12] Ueki, N., Kubo, J., Takayama, T., Kanari, I. and Uchiyama, M., *Vehicle Dynamics Electric Control Systems for Safe Driving*. http://www.hitachi.com/ICSFiles/afiedfile/2004/11/26/r2004_04_104_3.pdf.
- [13] Marcotte, T. D., Lazzaretto, D., Scott, J. C., Roberts, E. and Woods, S. P., Visual Attention Deficits are Associated with Driving Accidents in Cognitively-Impaired HIV-Infected Individuals. *Journal of Clinical and Experimental Neuropsychology*, 28:13–28, 2006.

- [14] Quek, F. and Petro, M., Human-Machine Perceptual Cooperation. Proceedings of the International Conference on Computer-Human Interaction INTERCHI'93: Human Factors in Computing Systems, 123-130, 1993.
- [15] Cleveland, W. S., The elements of graphing data. Wadsworth, Monterey, California, 1985.
- [16] Sanderson, P. M., Haskell, I. and Flach, J., The complex role of perceptual organization in visual display design theory, *Ergonomics* 35, 1199-1210, 1992.
- [17] Woods, D. D., Visual Momentum: A concept to improve the cognitive coupling of person and computer, *International Journal of Man-Machine Studies* 21, 229-244, 1984.
- [18] Card, S. K., Moran, T. P. and Newell, A., The psychology of human computer interaction, Lawrence Erlbaum Associates, Hillsdale, N.J., 1983.
- [19] Kieras, D. E. and Polson, P. G., An approach to the formal analysis of user complexity, *International Journal of Man-Machine Studies* 22, 365-394, 1985.
- [20] Brown, J. S. and Newman, S., Issues in cognitive and social ergonomics: from our house to bauhaus, *Human-Computer Interaction* 1, 359-391, 1985.
- [21] Norman, D. A., Things that make us smart. Reading, MA: Addison-Wesley, 1993.
- [22] Woods, D.D., Johannesen, L.J., Cook, R.I. and Sarter, N.B., Behind human error: cognitive systems, computers, and hindsight. Dayton, OH: CSERIAC, 1994.
- [23] Giacomini, J., Perception enhancement for steer-by-wire systems, *ATA Ingegneria dell' Automobile*, Vol. 58, No 8/9, Sept-Oct, 2005.
- [24] Tanner, W. P. and Swets, J. A., A decision-making theory of visual detection. *Psychological Review*, 61, 401-409, 1954.
- [25] Green, D. M. and Swets, J. A., Signal detection theory and psychophysics, reprint edition. Los Altos, CA: Peninsula Publishing, 1966.
- [26] Heeger, D., Signal Detection Theory. <http://www.cns.nyu.edu/~david/sdt/sdt.html>, 2003.
- [27] Palmer, J., Set-Size Effects in Visual Search: the Effect of Attention is Independent of the Stimulus for Simple Tasks. *Vision Res.* Vol. 34, No. 13, pp. 1703-1721, 1994.
- [28] Yonelinas, A. P., Dobbins, I., Szymanski, M. D., Dhaliwal, H. S. and King, L., Signal-Detection, Threshold, and Dual-Process Models of Recognition Memory: ROCs and Conscious Recollection. *Consciousness and Cognition* 5, 418-441, 1996.
- [29] De Carlo, L. T., Source monitoring and multivariate signal detection theory, with a model for selection. *Journal of Mathematical Psychology* 47, 292-303, 2003.
- [30] Gescheider, A. G., *Psychophysics The Fundamentals*, 3rd. edition, Lawrence Erlbaum Associates Publishers, London, 1997.
- [31] Baird, J. C. and Noma, E., *Fundamentals of Scaling and Psychophysics*. Wiley Series in Behaviour, 1978.
- [32] Giacomini, J. and Woo, Y.J., A study of the human ability to detect road surface type based on steering wheel vibration feedback, Proceedings of the IMechE, Part D - Journal of Automobile Engineering, Vol. 219, No. 11, pp 1259-1270, 2005.
- [33] Giacomini, J., Steinwolf, A. and Staszewski, W.J., An Algorithm for Mildly Non-stationary Mission Synthesis (MNMS). *Eng. Integrity*, 44-56, 2000.
- [34] Chui, C.K., *Introduction to wavelets*, Academic Press, New York USA, 1991.
- [35] Daubechies, I., *Ten Lectures on Wavelets*, SIAM, Philadelphia USA, 1992.
- [36] Gearing & Watson Electronics Ltd, *Manual of G&W V20 electrodynamic shaker*, 1995.
- [37] Entran Devices Inc., *Manual of Entran MSC6*, 1991.
- [38] LMS International, *LMS Cada-X TMON Manual*, 1996.